

CKA 300 P - CKA 300 PP

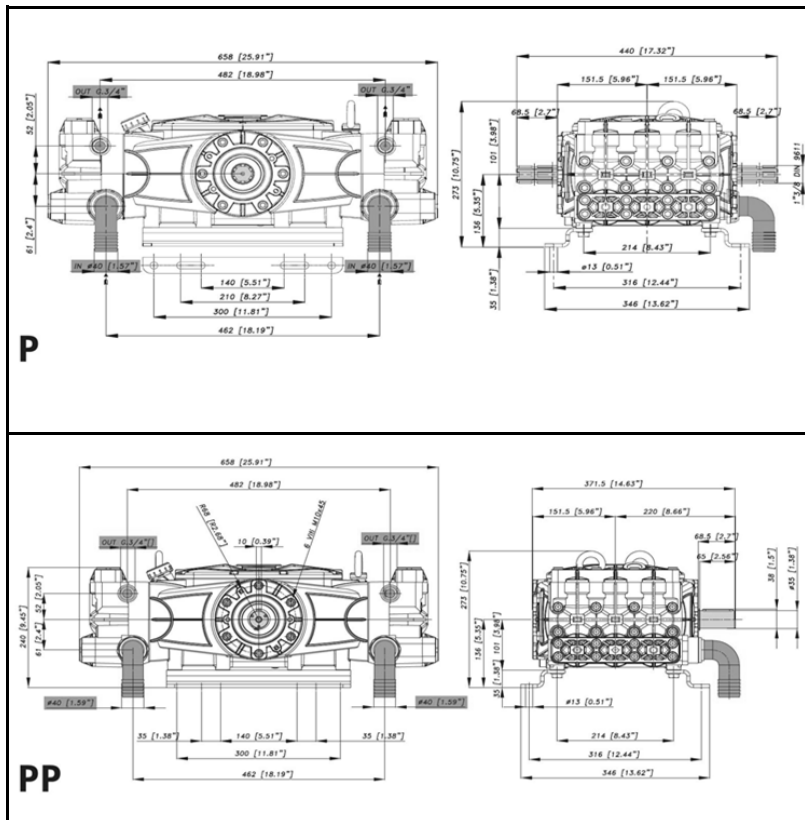

DIMENSIONI D'INGOMBRO - OVERALL DIMENSIONS



ALBERO POMPA - PUMP SHAFT

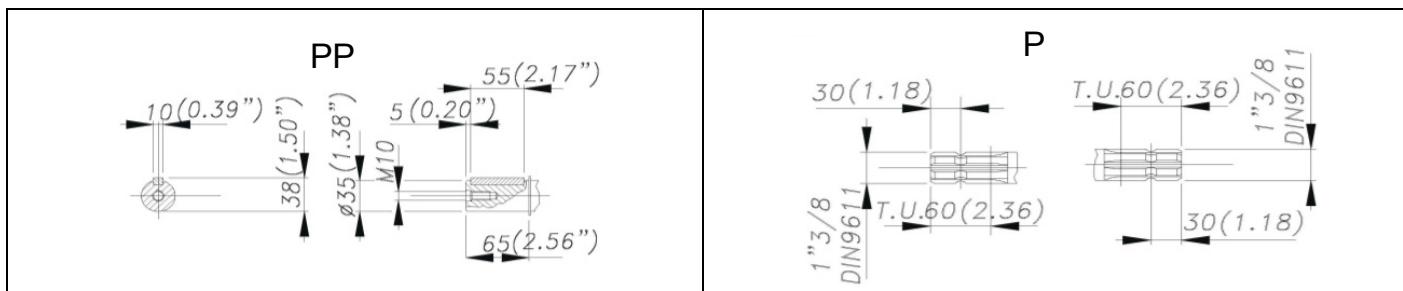

COPPIA DI SERRAGGIO - TORQUE CHART

CODICE - CODE	Q.TY	POS	N-m	Lbr.ft
86.4120.00.2	16	2	68	50.2
86.3910.00.2	32	4	68	50.2
85.2693.53.2	2	8	40	29.5
86.4091.00.2	6	26	50 (LOXEAL 55-14)	36.9 (LOXEAL 55-14)
86.1930.00.2	12	51	5	3.7
86.3439.00.2	6	44	40	29.5
86.2166.00.2	10	55	10	7.4
86.3694.50.2	1	57	68	50
86.3740.00.2	8	58	68 (LOXEAL 55-14)	50.2 (LOXEAL 55-14)
85.3507.00.2	1	62	10	7.4
86.3265.00.2	12	67	40	29.5
86.2475.00.2	2	70	10	7.4

Tolleranza di serraggio: 0/-10%
Tolerance on torque value:

INFORMAZIONI UTILI USEFUL INFORMATION

LUBRIFICANTE-LUBRICANT:
OLIO MOTORE O SEMIIDRAULICO SAE 30
MOTOR OIL OR SEMI-HYDRAULIC OIL SAE 30



CKA 300 P

CKA 300 PP

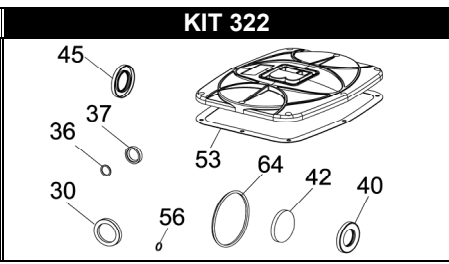
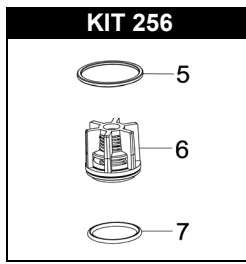
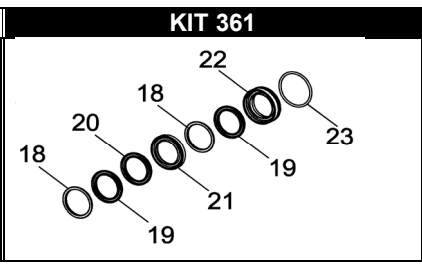
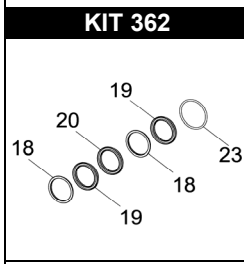
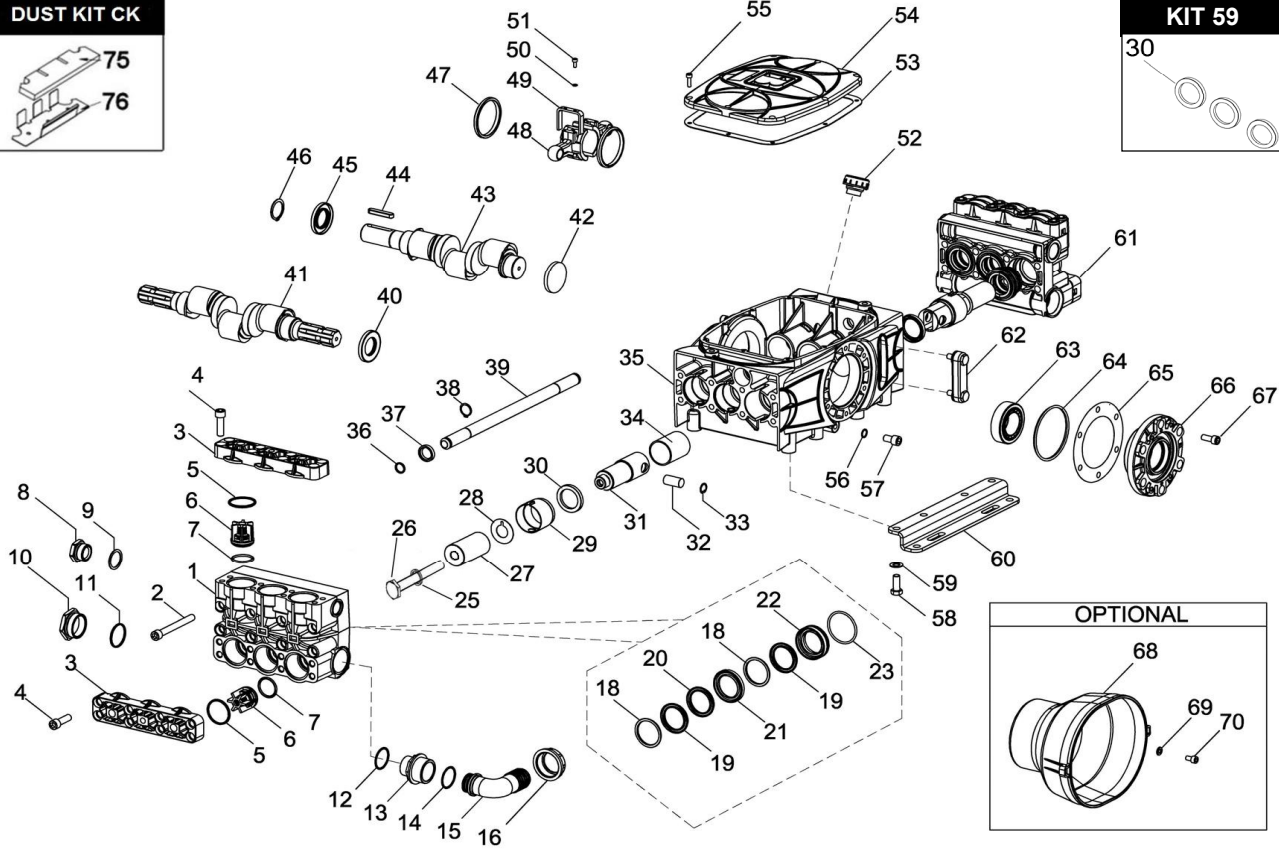
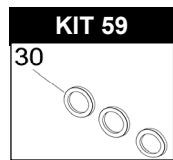
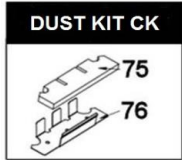

POS.	CODICE PART NO. RÉF.	DENOMINAZIONE - DESCRIPTION - DESCRIPTION	Q.TY
1	760238092	LEFT PUMP HEAD	1
2	864120002	BOLT M12X110 UNI 5931	16
3	730416092	VALVES COVERS	4
4	863910002	BOLT M12X40 UNI 5931	32
5-kit 256	803270002	O-RING DIA.3,53X49,02	12
6-kit 256	739824973	VALVE ASSY	12
7-kit 256	803253002	O-RING DIA.3,53X49,02	12
8	852693532	PLUG G.3/4"	2
9	803218002	O-RING DIA.3X22	2
10	852752002	PLUG G.1" 1/2	2
11	803265002	O-RING	2
12	803265002	O-RING	2
13	835092502	NIPPLE G.1" 1/2-1" 3/4	2
14	803208502	O-RING DIA.2,62X37,77	2
15	840595002	90° ELBOW CONNECTOR DIA.40	2
16	820095002	WING NUT 1" 3/4	2
18-kit 57-122	730047322	THRUST RING DIA.45	12
19-kit 57-122	802232002	"V" PACKING DIA.45X60	12
20-kit 57-122	730767322	ANTIEXTRUSION RING DIA.45	6
21-kit 122	730769532	FRONT GLAND	6
22-kit 122	730768532	BACK GLAND	6
23-kit 57-122	803283002	O-RING DIA.3,53X58,74	6
25	843898002	COPPER WASHER D. 12X20X1,5	6
26	864091002	BOLT M12X40 UNI 5923 STAINLESS STEEL	6
27	730550182	PISTON DIA.45	6
28	844212002	SPLASH GUARD WASHER	6
29	730528322	OIL SEAL SPACER	6
30-kit 59-322	802180102	OIL SEAL	6
31	730485512	PLUNGER ROD	6
32	852007402	PIN	6
33	800040002	SNAP RING DIA.18	12
34	804470002	BUSHING	6
35	760360082	PUMP CRANKCASE	1
36-kit 322	803217302	O-RING DIA.3X16	4
37-kit 322	802089002	OIL SEAL	2
38	801160002	SNAP RING DIA.22	2
39	760366822	HEADS CONNECTION PIPE	1
40-kit 322	802153002	OIL SEAL (P VERSIONS)	1

POS.	CODICE PART NO. RÉF.	DENOMINAZIONE - DESCRIPTION - DESCRIPTION	Q.TY
41	730367262	CRANKSHAFT CKA 300 P	1
42-kit 322	802102002	RCA CAP (PP VERSIONS)	1
43	730364262	CRANKSHAFT CKA 300 PP	1
44	806585002	TAB 10X8X55 (PP VERSIONS)	1
45	802153002	OIL SEAL	1
46	801264002	SNAP RING DIA.35 (PP VERSIONS)	1
47	760047762	CONNECTING RODS RING	6
48	760010092	CONNECTIONG ROD	6
49	760046612	FORK	6
50	843651502	WASHER	12
51	861930002	BOLT M5X12 UNI 5931	12
52	853542002	OIL FILLING PLUG G.3/4"	1
53-kit 322	760364722	CRANKCASE COVER GASKET	1
54	760362082	CRANKCASE COVER	1
55	862166002	BOLT M8X20 UNI 5931	10
56-kit 322	824079002	COPPER WASHER	1
57	863694502	BOLT M12X20 UNI 5931	1
58	863740002	BOLT M12X30 UNI 5739	8
59	843906002	ELASTIC WASHER UNI 1751	8
60	730365612	MOUNTING BRACKET	2
61	760237092	RIGHT PUMP HEAD	1
62	853507002	OIL SIGHT GLASS	1
63	812940002	CONICAL ROLLER BEARING DIA.45X80X26	2
64-kit 322	803291052	O-RING DIA.3,53X98,02	2
65	730354652	SHIM 0,1 mm	1
65	730355652	SHIM 0,2 mm	2
66	730368082	BEARING COVER	2
67	863265002	BOLT M10X25 UNI 5931	12
68	311482322	PLAIN SAFETY CONE (OPTIONAL)	1
69	843696002	WASHER (OPTIONAL)	2
70	862475002	BOLT M8X14 UNI 5931 (OPTIONAL)	2
75 DUST KIT	760368722	DUST SHEET	1
76 DUST KIT	760367612	DUST FILTER	1
REPAIR KIT	NO.s INCLUDED	PCS.	
kit 256	769853973	SPARE PARTS KIT	36
kit 361	769893973	SPARE PARTS KIT	48
kit 362	769894973	SPARE PARTS KIT	36
kit 59	769812973	SPARE PARTS KIT	6
kit 322	769883973	SPARE PARTS KIT	18
Dust kit CK	730531973	SPARE PARTS KIT	4