

DIMENSIONI D'INGOMBRO - OVERALL DIMENSIONS

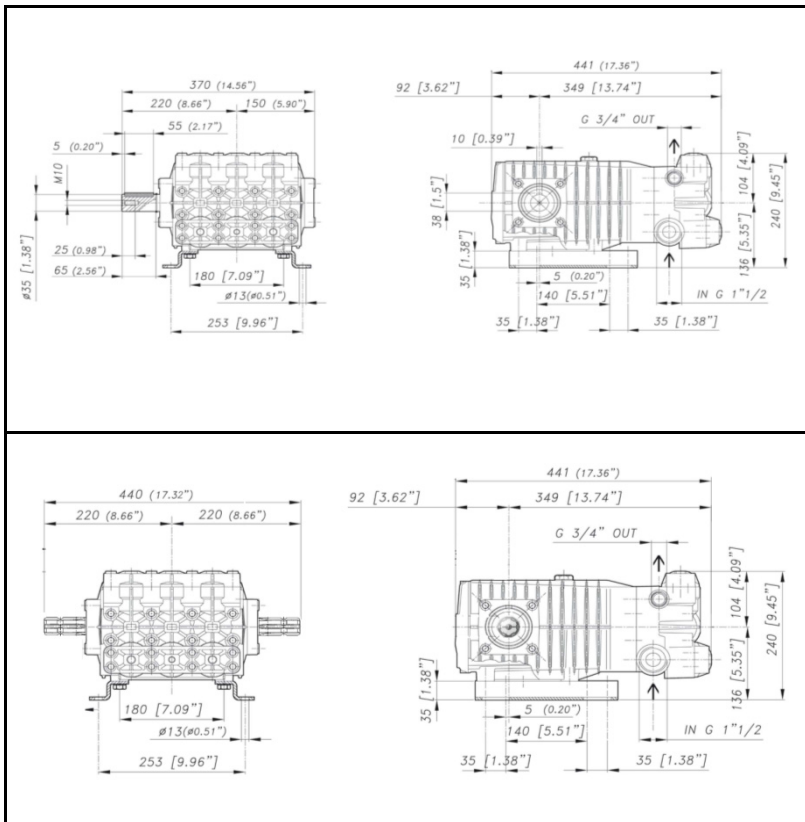

ALBERO POMPA - PUMP SHAFT

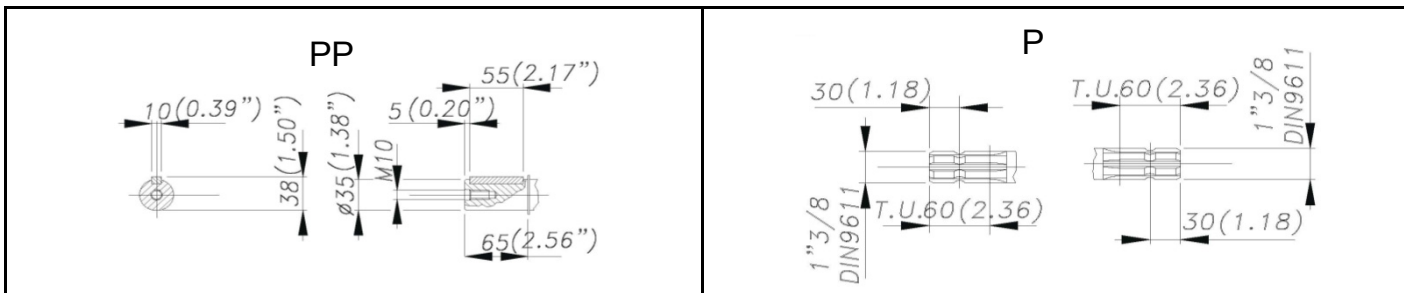

COPPIA DI SERRAGGIO - TORQUE CHART

CODICE - CODE	Q.TY	POS	N.m	Lbr.ft
86.3910.00.2	16	4	68	50.2
86.4120.00.2	8	5	68	50.2
86.3703.00.2	4	28	68	50.2
86.3696.00.2	8	32	40	29.6
86.2216.00.2	10	43	10	7.4
86.3439.00.2	6	44	40	29.5
86.3900.00.2	3	62	40 (LOXEAL 54-03)	29.6 (LOXEAL 54-03)
73.0342.51.2	3	63	40 (LOXEAL 54-03)	29.6 (LOXEAL 54-03)

Tolleranza di serraggio: 0/-10%
Tolerance on torque value: 0/-10%

INFORMAZIONI UTILI USEFUL INFORMATION

LUBRIFICANTE - LUBRICANT:
OLIO MOTORE O SEMIIDRAULICO SAE 30
MOTOR OIL OR SEMI-HYDRAULIC OIL SAE 30



CK 150 P - CK 150 PP

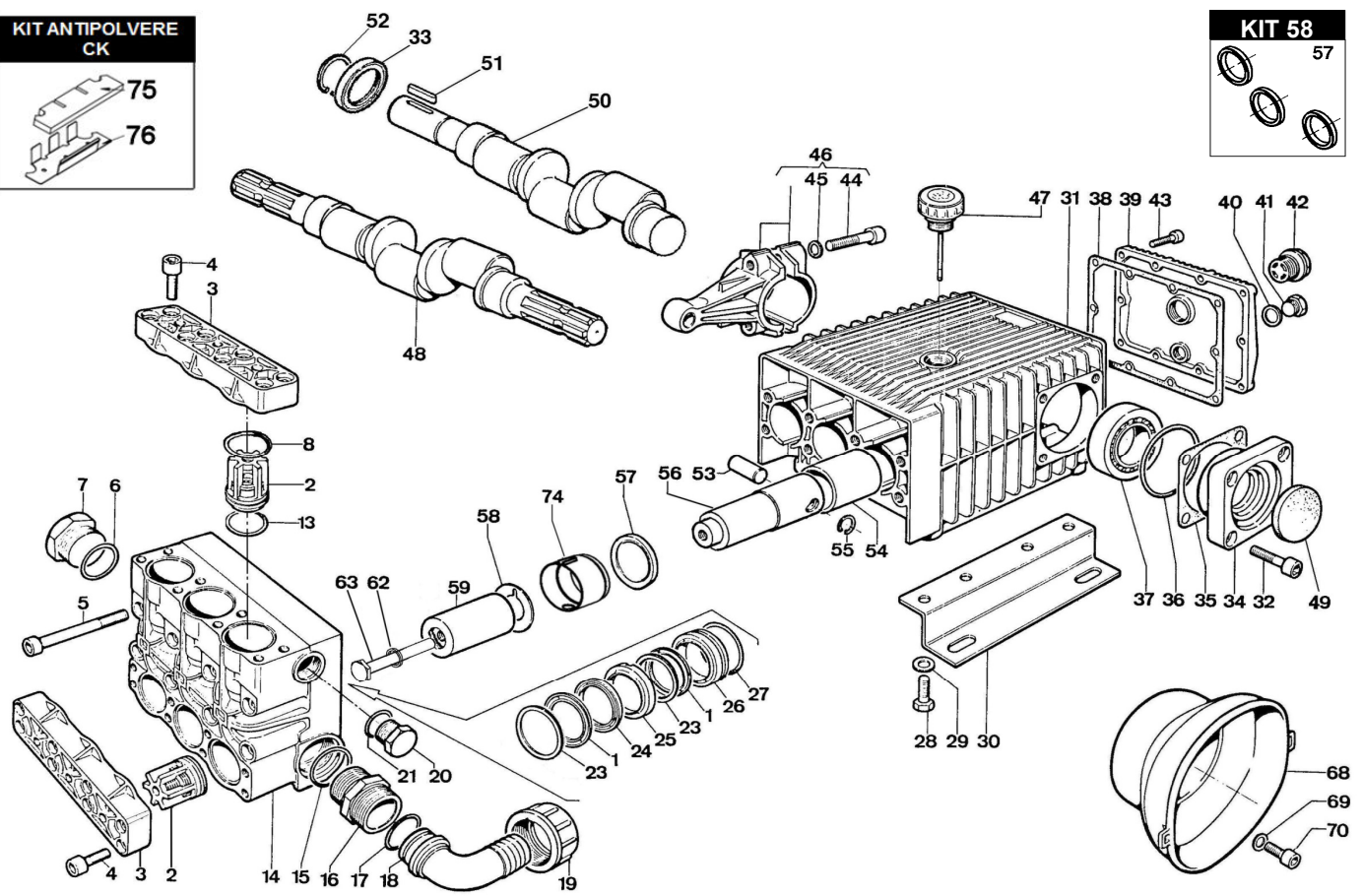
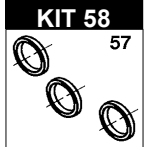

KIT 360

KIT 359

KIT 186

KIT 187

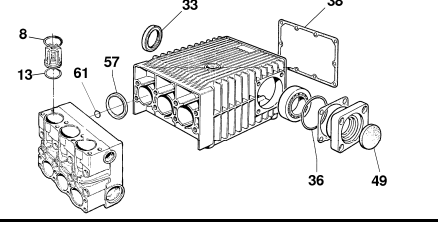
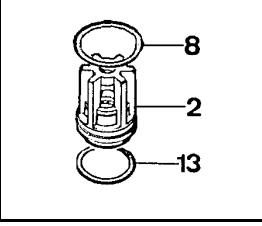
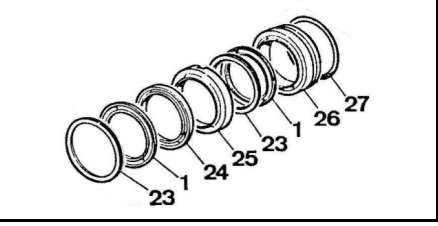
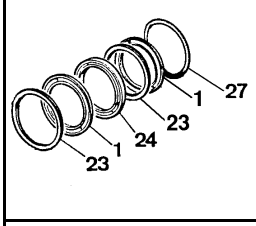

POS.	CODICE PART NO. RÉF.	DENOMINAZIONE - DESCRIPTION - DESCRIPTION	Q.TY
1	802232002	GUARNIZIONE V 50-60	6
2-KIT 186	739824973	GR. VALVOLA A/M	6
3	730416092	COPERCHIO VALVOLE	2
4	863910002	VITE TCEI UNI5931	16
5	864120002	VITE TCEI UNI5931	8
6	803209602	ANELLO OR	1
7	852752002	TAPPO G.1"1/2	1
8 KIT 186-187	803270002	ANELLO OR	6
13 KIT 186-187	803253002	ANELLO OR	6
14	730761092	CORPO POMPA	1
15	803209602	ANELLO OR	1
16	835092502	NIPPLO G.1"1/2-G.1"3/4	1
17	803208502	ANELLO OR	1
18	840595002	RACCORDO CURVO D.40-1,57"	1
19	820095002	GALLETTO G.1"3/4	1
20	852693532	TAPPO G.3/4	1
21	803218002	ANELLO OR	1
23 KIT 359-360	730047322	ANELLO DI SPINTA	6
24 KIT 359-360	730767322	ANELLO ANTIESTRUSIONE	3
25 KIT 359	730769532	LANTERNA ANTERIORE	3
26 KIT 359	730768532	LANTERNA POSTERIORE	3
27 KIT 359-360	803283002	ANELLO OR	3
28	863703002	VITE TE UNI5739	6
29	843906002	ROSETTA ELS UNI1751	6
30	730024612	PIEDINO POMPA	2
31	730525092	CARTER POMPA	1
32	863696002	VITE TCEI UNI5931	8
33 KIT-187	802143002	ANELLO RADIALE	2÷1
34	730411092	SUPP. CUSCINETTO	2
35/1	730413652	SPESSORE SP.0,1	1
35/2	730414652	SPESSORE SP.0,2	1
36 KIT-187	803210672	ANELLO OR	2
37	812940002	CUSCINETTO 45X80X26	2
38 KIT-187	730065722	GUARNIZIONE COPERCHIO POSTERIORE	1
39	730002092	COPERCHIO POSTERIORE	1
40	824107002	GUARNIZIONE	1
41	852579002	TAPPO G.3/8	1

POS.	CODICE PART NO. RÉF.	DENOMINAZIONE - DESCRIPTION - DESCRIPTION	Q.TY
42	853515502	SPIA LIVELLO OLIO CON OR	1
43	862216002	VITE TCEI UNI5931	10
44	863439002	VITE TCEI UNI5931	6
45	843870002	ROSETTA SCHNORR	6
46	739802973	BIELLA COMPLETA	3
47	853516002	TAPPO OLIO	1
48	730367262	ALBERO ECCENTRICO CK 150 P	1
49 KIT-187	802099602	CAPPELLOTTO	1
50	730364262	ALBERO ECCENTRICO CK 150 PP	1
51	806585002	LINGUETTA	1
52	801264002	ANELLO ELASTICO PER ALBERO	1
53	852007402	SPINOTTO	3
54	804470002	BOCCOLA AUTOLUBRIFICANTE	3
55	800040002	ANELLO ELASTICO PER FORO	6
56	730485512	GUIDA PISTONE	3
57 KIT 58-187	802180102	ANELLO RADIALE	3
58	844212002	ROSETTA PARASPRUZZI	3
59	730550182	PISTONE CERAMICO D.50	3
62	843898002	ROSETTA RAME 12X20X1,5	3
63	864091002	VITE BLOCCAGGIO PISTONE	3
68	311482322	CUFFIA DI PROTEZIONE (OPTIONAL)	1
69	843710002	ROSETTA D.9X24X2 UNI 6593 (OPTIONAL)	2
70	862475002	VITE TCEIM8X14 UNI 5931 (OPTIONAL)	2
74	730528322	DISTANZIALE ANELLO RADIALE	3
75 KIT ANTIPOLVERE	730531722	FILTRO ANTIPOLVERE CK	1
76 KIT ANTIPOLVERE	730531612	LAMIERA ANTIPOLVERE POMPE CK	1

REPAIR KIT	NO.s INCLUDED	PCS.	
KIT 58	739842973	KIT RICAMBI	3
KIT 186	739871973	KIT RICAMBI	18
KIT 187	731028973	KIT RICAMBI	24
KIT 359	739939973	KIT RICAMBI	24
KIT 360	739940973	KIT RICAMBI	18
KIT ANTIPOLVERE CK	730531973	KIT RICAMBI	2

