

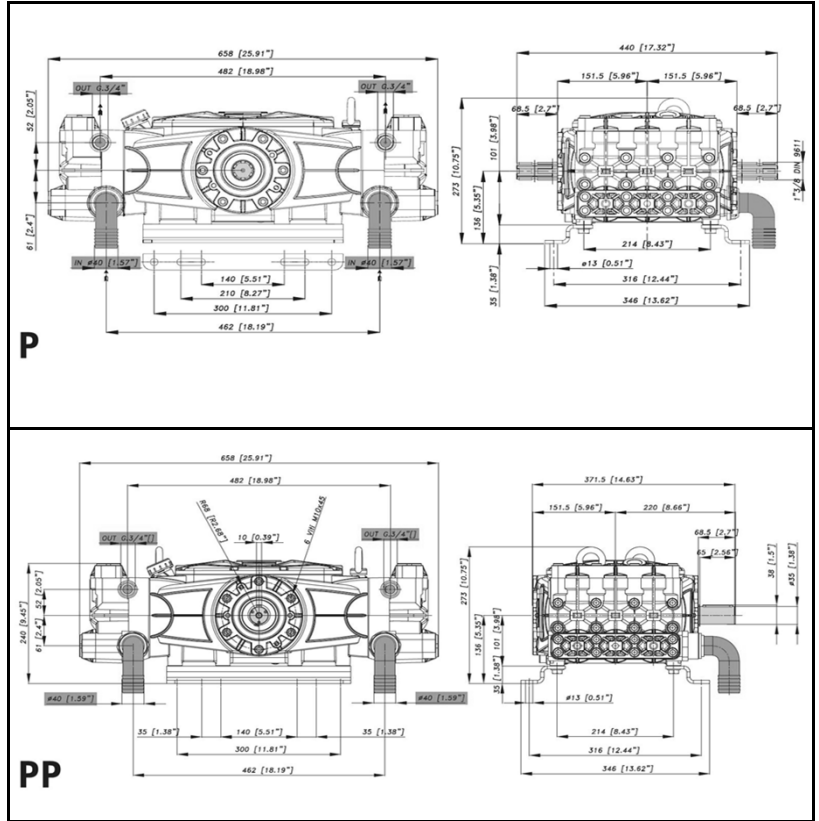

DIMENSIONI D'INGOMBRO - OVERALL DIMENSIONS

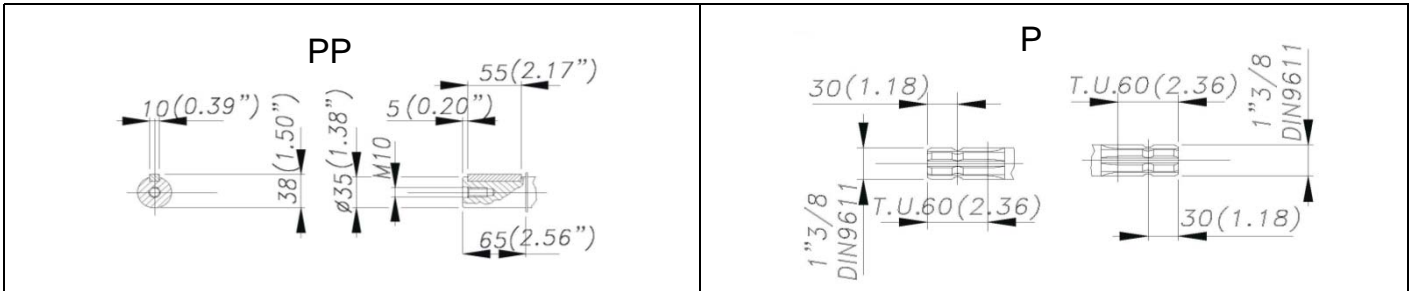

ALBERO POMPA - PUMP SHAFT



COPPIA DI SERRAGGIO - TORQUE CHART

CODICE - CODE	Q.TY	POS	N-m	Lbr.ft
86.4120.00.2	16	2	68	50.2
86.3910.00.2	32	4	68	50.2
85.2693.53.2	2	8	40	29.5
86.4091.00.2	6	26	50 (LOXEAL 55-14)	36.9 (LOXEAL 55-14)
86.1930.00.2	12	51	5	3.7
86.3439.00.2	6	44	40	29.5
86.2166.00.2	10	55	10	7.4
86.3694.50.2	1	57	68	50
86.3740.00.2	8	58	68 (LOXEAL 55-14)	50.2 (LOXEAL 55-14)
85.3507.00.2	1	62	10	7.4
86.3265.00.2	12	67	40	29.5
86.2475.00.2	2	70	10	7.4

Tolleranza di serraggio: 0/-10%
Tolerance on torque value:



INFORMAZIONI UTILI
USEFUL INFORMATION

LUBRIFICANTE- LUBRICANT:
OLIO MOTORE O SEMIIDRAULICO SAE 30
MOTOR OIL OR SEMI-HYDRAULIC OIL SAE 30

CK 280 P

CK 280 PP

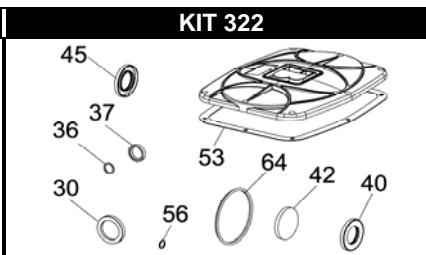
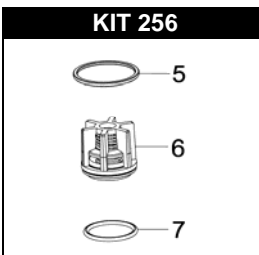
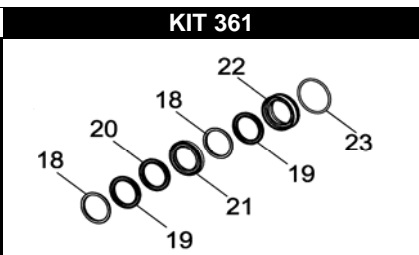
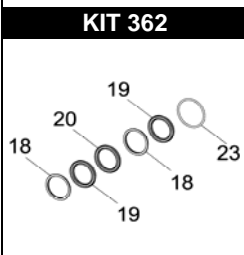
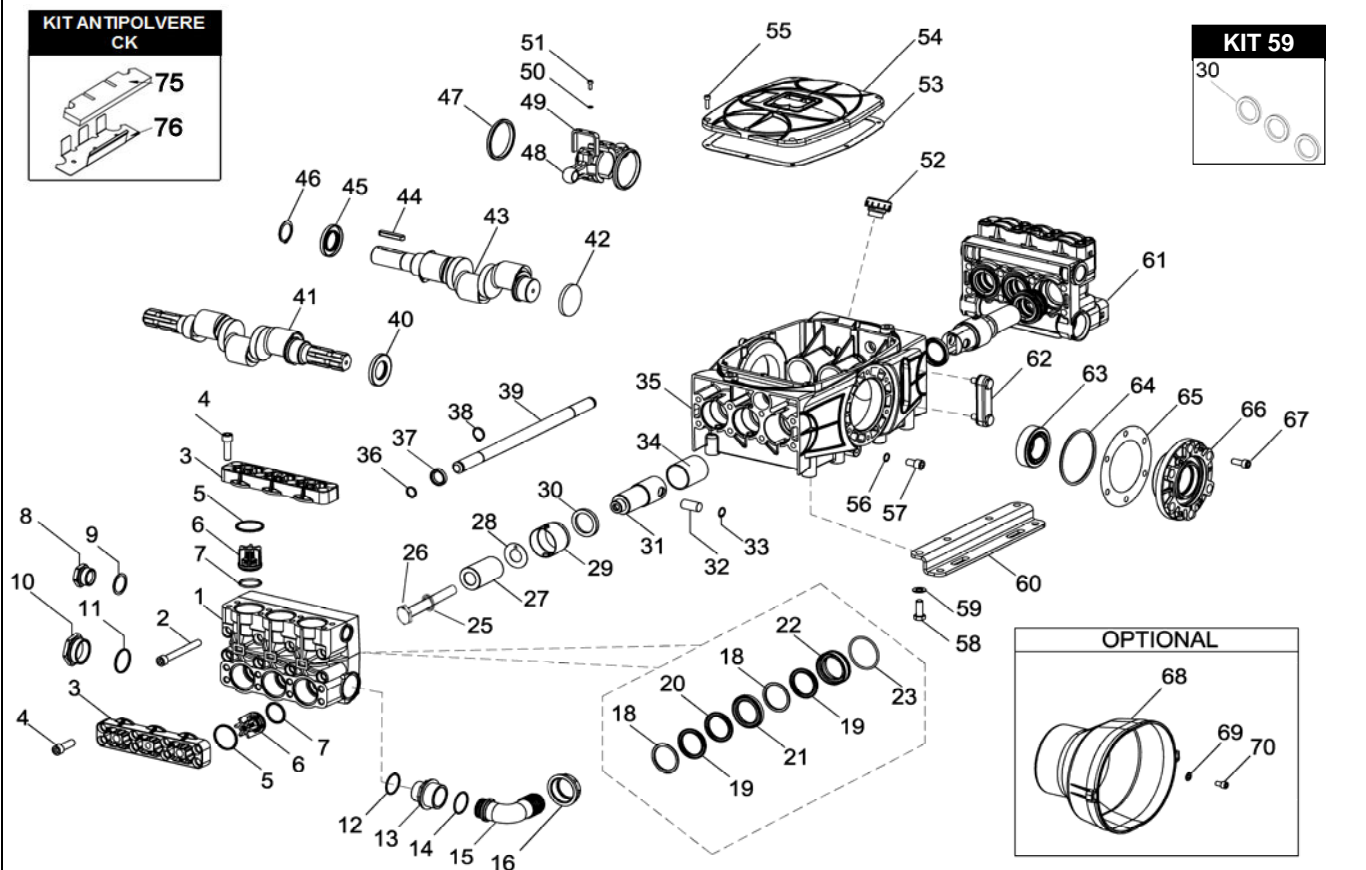

POS.	CODICE PART NO. RÉF.	DENOMINAZIONE - DESCRIPTION - DESCRIPTION	Q.TY
1	760238092	CORPO POMPA SINISTRO	1
2	864120002	VITE	16
3	730416092	COPERCHIO VALVOLE	4
4	863910002	VITE	32
5-kit 256	803270002	ANELLO OR	12
6-kit 256	739824973	GRUPPO VALVOLA	12
7-kit 256	803253002	ANELLO OR	12
8	852693532	TAPPO G.3/4"	2
9	803218002	ANELLO OR	2
10	852752002	TAPPO G.1" 1/2	2
11	803265002	ANELLO OR	2
12	803265002	ANELLO OR	2
13	835092502	NIPPLO	2
14	803208502	ANELLO OR	2
15	840595002	RACCORDO CURVO D.40	2
16	820095002	GALLETTO G.1" 3/4	2
18-kit 361-362	730047322	ANELLO DI SPINTA	12
19-kit 361-362	802232002	GUARNIZIONE V 50-60	12
20-kit 361-362	730767322	ANELLO ANTIESTRUSIONE	6
21-kit 361	730769532	LANTERNA ANTERIORE	6
22-kit 361	730768532	LANTERNA POSTERIORE	6
23-kit 361-362	803283002	ANELLO OR	6
25	863898002	ROSETTA RAME 12X20X1.5	6
26	864091002	VITE BLOCCAGGIO PISTONE	6
27	730550182	PISTONE CERAMICO D.50	6
28	844212002	ROSETTA PARASPRUZZI	6
29	730528322	DISTANZIALE ANELLO RADIALE	6
30-kit 59-322	802180002	ANELLO RADIALE	6
31	730485512	GUIDA PISTONE	6
32	852007402	SPINOTTO	6
33	800040002	ANELLO ELASTICO	12
34	804470002	BOCCOLA AUTOLUBRIFICANTE	6
35	760361082	CARTER POMPA	1
36-kit 322	803217302	ANELLO OR	4
37-kit 322	802089002	ANELLO RADIALE	2
38	801160002	ANELLO ELASTICO	2
39	760366822	TUBO COLLEGAMENTO MANDATE	1
40-kit 322	802153002	ANELLO RADIALE (VERSIONI P)	1

POS.	CODICE PART NO. RÉF.	DENOMINAZIONE - DESCRIPTION - DESCRIPTION	Q.TY
41	730367262	ALBERO CK 280 P	1
42-kit 322	802102002	CAPPELLOTTO RCA (VERSIONI PP)	1
43	730363262	ALBERO CK 280 PP	1
44	806585002	LINGUETTA (VERSIONI PP)	1
45	802153002	ANELLO RADIALE	1
46	801264002	ANELLO ELASTICO (VERSIONI PP)	1
47	760047762	ANELLO SERRAGGIO BIELLE	6
48	760010092	BIELLA	6
49	760046612	FORCELLA	6
50	843651502	ROSETTA	12
51	861930002	VITE	12
52	853541002	TAPPO OLIO	1
53-kit 322	760364722	GUARNIZIONE COPERCHIO CARTER	1
54	760363082	COPERCHIO CARTER	1
55	862166002	VITE	10
56-kit 322	824079002	ROSETTA IN RAME	1
57	863694502	VITE	1
58	863740002	VITE	8
59	843906002	ROSETTA ELASTICA UNI 1751	8
60	760365612	PIEDE	2
61	760237092	CORPO POMPA DESTRO	1
62	853507002	SPIA LIVELLO OLIO	1
63	812940002	CUSCINETTO RULLI CONICI	2
64-kit 322	803291052	ANELLO OR	2
65	730354652	SPESSORE 0,1	1
65	730355652	SPESSORE 0,2	2
66	730369082	SUPPORTO CUSCINETTO	2
67	863265002	VITE	12
68	311482322	CUFFIA (OPTIONAL)	1
69	843696002	RONDELLA (OPTIONAL)	2
70	862475002	VITE (OPTIONAL)	2
75 KIT ANTIPOLVERE	730531722	FILTRO ANTIPOLVERE	2
76 KIT ANTIPOLVERE	730531612	LAMIERA ANTIPOLVERE	2
REPAIR KIT	NO,s INCLUDED		PCS.
kit 256	769853973	KIT RICAMBI	36
kit 361	769893973	KIT RICAMBI	48
kit 362	769894973	KIT RICAMBI	36
kit 59	769812973	KIT RICAMBI	6
kit 322	769883973	KIT RICAMBI	18
KIT ANTIPOLVERE	730531973	KIT RICAMBI	4