

CPQ 9020.1

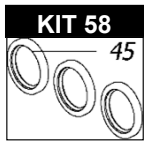

KIT 58

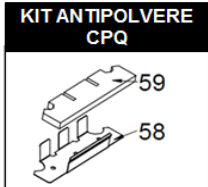
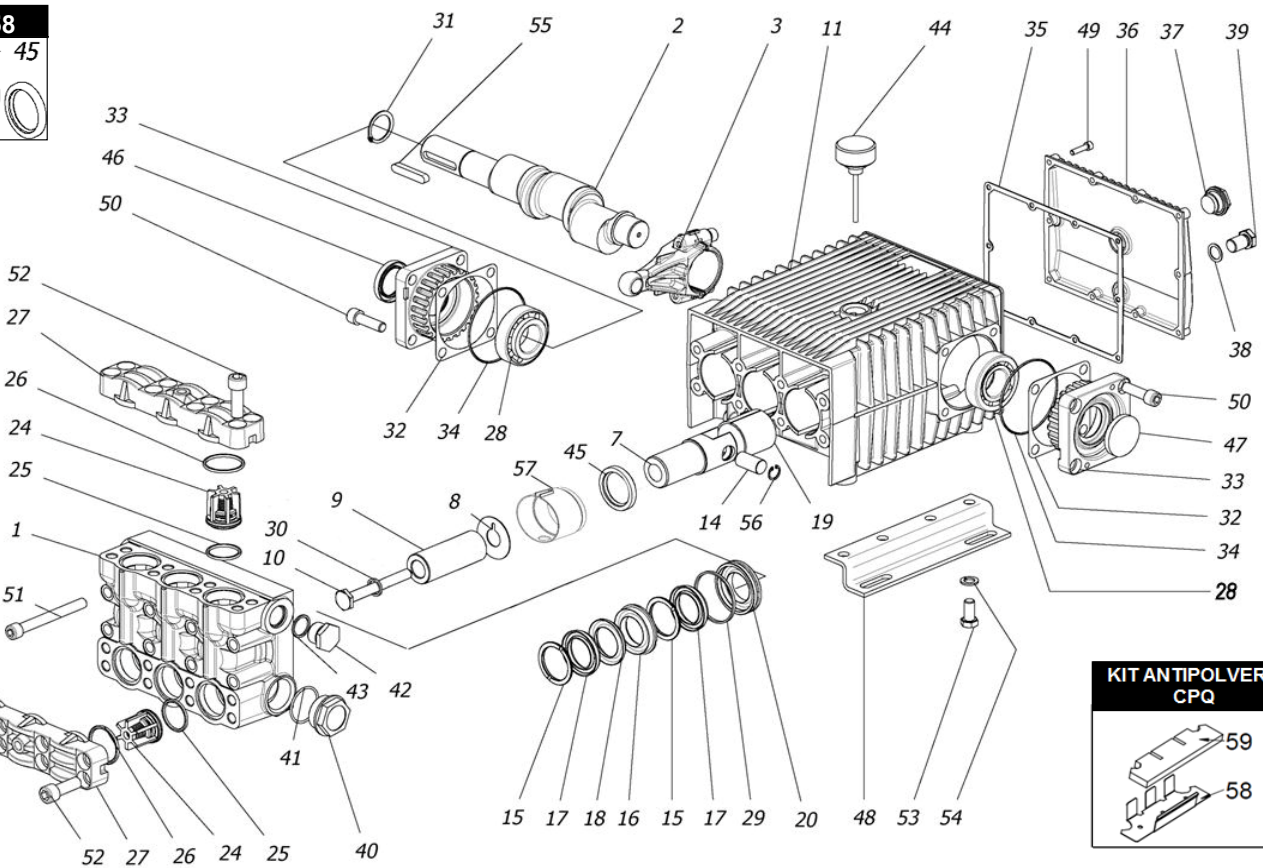

KIT ANTIPOLVERE CPQ

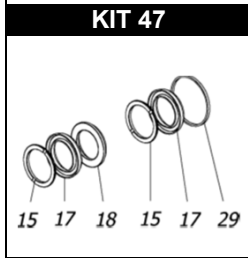

KIT 47

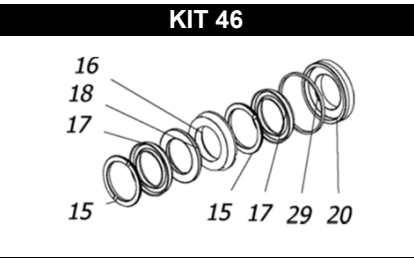

KIT 46

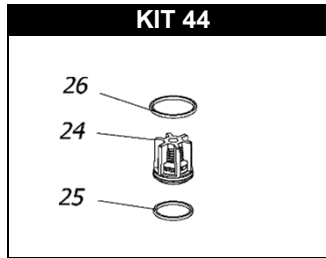

KIT 44

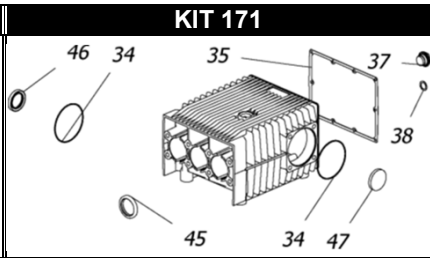

KIT 171

| POS. | CODICE PART NO. RÉF. | DENOMINAZIONE - DESCRIPTION - DESCRIPTION | Q.TY |
|---------------|----------------------|---|------|
| 1 | 730486282 | CORPO POMPA | 1 |
| 2 | 730344262 | ALBERO | 1 |
| 3 | 730482112 | BIELLA | 3 |
| 7 | 730523512 | GUIDA PISTONE | 3 |
| 8 | 844212002 | ROSETTA PARASPRUZZI | 3 |
| 9 | 730459182 | PISTONE 30X79 | 3 |
| 10 | 864091002 | VITE M12X100 UNI 5737 INOX | 3 |
| 11 | 730506092 | CARTER SERIE CK | 1 |
| 14 | 730484492 | SPINOTTO | 3 |
| 15 -Kit 46-47 | 730309322 | ANELLO DI SPINTA | 6 |
| 16 -Kit 46 | 730307532 | LANTERNA ANTERIORE | 3 |
| 17 -Kit 46-47 | 802165002 | GUARNIZIONE V 30 - 45 | 6 |
| 18 -Kit 46-47 | 730035322 | ANELLO ANTIESTRUSIONE | 3 |
| 19 | 804470002 | BOCCOLA AUTOLUBRIFICANTE | 3 |
| 20 -Kit 46 | 730446532 | LANTERNA POSTERIORE | 3 |
| 24 -Kit 44 | 739824973 | GR. VALVOLA | 6 |
| 25 -Kit 44 | 803253002 | ANELLO OR | 6 |
| 26 -Kit 44 | 803263002 | ANELLO OR | 6 |
| 27 | 730126282 | COPERCHIO VALVOLE | 2 |
| 28 | 812940002 | CUSCINETTO | 2 |
| 29 -Kit 46-47 | 803283002 | ANELLO OR | 3 |
| 30 | 843898002 | ROSETTA RAME | 3 |
| 31 | 801284002 | ANELLO ELASTICO D.35 | 1 |
| 32 | 730413652 | SPESSORE 0.1 | 1 |
| 32 | 730414652 | SPESSORE 0.2 | 2 |
| 33 | 730477092 | SUPPORTO CUSCINETTO | 2 |
| 34 -Kit 171 | 803210672 | ANELLO OR | 2 |
| 35 -Kit 171 | 730065722 | GUARNIZIONE | 1 |

| POS. | CODICE PART NO. RÉF. | DENOMINAZIONE - DESCRIPTION - DESCRIPTION | Q.TY |
|---------------------------------------|----------------------|---|-------|
| 36 | 730475092 | COPERCHIO POSTERIORE | 1 |
| 37 -Kit 171 | 853515502 | SPIA OLIO | 1 |
| 38 -Kit 171 | 824107002 | GUARNIZIONE | 1 |
| 39 | 852579002 | TAPPO G 3/8" | 1 |
| 40 | 852753532 | TAPPO G 1"1/2 | 1 |
| 41 | 803209102 | ANELLO OR | 1 |
| 42 | 852712532 | TAPPO G 1" | 1 |
| 43 | 824230002 | GUARNIZIONE IN RAME | 1 |
| 44 | 853516002 | TAPPO CARICO OLIO | 1 |
| 45 -Kit 58-171 | 802180002 | ANELLO RADIALE | 3 |
| 46 -Kit 171 | 802143002 | ANELLO RADIALE | 1 |
| 47 -Kit 171 | 802099602 | CAPPELLOTTO | 1 |
| 48 | 730024612 | PIEDINO | 2 |
| 49 | 862216002 | VITE | 10 |
| 50 | 863696002 | VITE | 8 |
| 51 | 864120002 | VITE | 8 |
| 52 | 864200002 | VITE | 16 |
| 53 | 863703002 | VITE | 6 |
| 54 | 843844002 | ROSETTA | 6 |
| 55 | 806585002 | LINGUETTA | 1 |
| 56 | 801161002 | ANELLO ELASTICO | 6 |
| 57 | 730528322 | DISTANZIALE ANELLO RADIALE | 3 |
| 58 - KIT ANTIPOLVERE CPQ | 730531612 | LAMIERA ANTIPOLVERE | 1 |
| 59 - KIT ANTIPOLVERE CPQ | 730531722 | FILTRO ANTIPOLVERE | 1 |
| REPAIR KIT | | ITEM NO.s INCLUDED | P.CS. |
| KIT 44 | 739835973 | KIT RICAMBI | 18 |
| KIT 46 | 739836973 | KIT RICAMBI | 24 |
| KIT 47 | 739837973 | KIT RICAMBI | 18 |
| KIT 58 | 739842973 | KIT RICAMBI | 3 |
| KIT ANTIPOLVERE CPQ | 730531973 | KIT RICAMBI | 2 |
| KIT 171 | 739872973 | KIT RICAMBI | 10 |
| HOT WATER CONVERSION KIT (85°C-185°F) | | | |
| kit 203 | 739874973 | KIT GUARNIZIONI H.W. | 24 |
| kit 251 | 739916973 | KIT VALVOLE H.W. | 18 |