

# RAS 5062-H PREMIUM

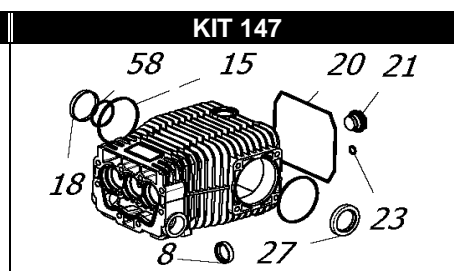
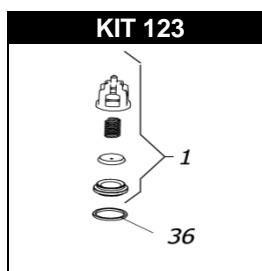
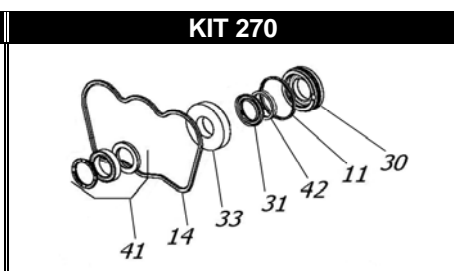
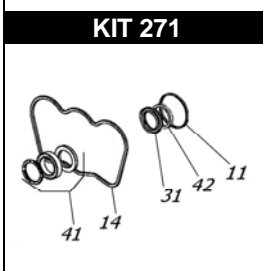
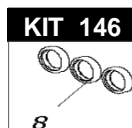
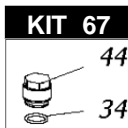
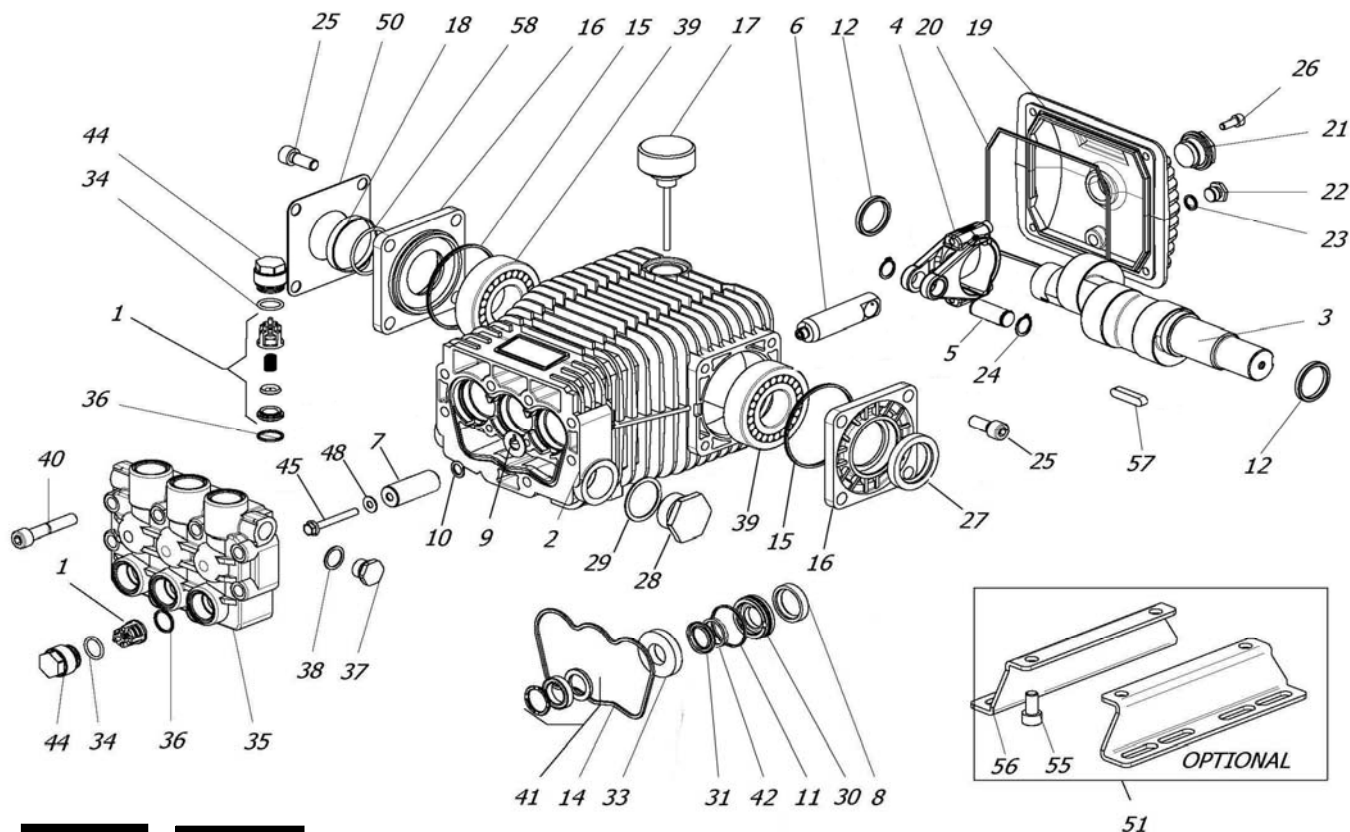

POS.	CODICE PART NO. RÉF.	DENOMINAZIONE - DESCRIPTION - DESCRIPTION	Q.TY
1-kit 123	069846973	GR. VALVOLA	6
2	080001092	CARTER	1
3	080241262	ALBERO (RAL 2535-H)	1
3	080245262	ALBERO (RAL 2335-H)	1
3	080246262	ALBERO (RAL 2035-H RAS 5062-H)	1
4	080289112	BIELLA	3
5	080243492	SPINOTTO	3
6	080270512	GUIDA PISTONE	3
7	080070182	PISTONE D.20	3
8-kit 146-147	802092002	ANELLO RADIALE	3
9	843827002	ROSETTA	3
10	080274532	DISTANZIALE PISTONE	3
11-kit 270-271	803080102	ANELLO OR	3
12	080271412	DISTANZIALE CUSCINETTI	2
14-kit 270-271	080021312	GUARNIZIONE SAGOMATA	1
15-kit 147	803210642	ANELLO OR	2
16	060017092	COPERCHIO CUSCINETTO	2
17	060020322	TAPPO CARICO OLIO	1
18-kit 147	060019322	INDICATORE LIVELLO OLIO (DA 06/2020)	1
18	060059322	INDICATORE LIVELLO OLIO (FINO A 06/2020)	1
19	080006092	COPERCHIO POSTERIORE	1
20-kit 147	803210882	ANELLO OR	1
21-kit 147	853515502	SPIA OLIO + OR	1
22	852543502	TAPPO G1/4X9	1
23-kit 147	803057002	ANELLO OR	1
24	801140002	ANELLO ELASTICO	6
25	863265002	VITE	8
26	862108002	VITE	4
27-kit 147	802143002	ANELLO DI TENUTA	1
28	852712002	TAPPO G1	1
28	852712532	TAPPO G1 OT (OPTIONAL)	1
29	824230002	GUARNIZIONE	1

POS.	CODICE PART NO. RÉF.	DENOMINAZIONE - DESCRIPTION - DESCRIPTION	Q.TY
30-kit 270	080118532	LANTERNA POSTERIORE	3
31-kit 270-271	802301102	GUARNIZIONE U 20-28	3
33-kit 270	080114532	LANTERNA ANTERIORE	3
34-kit 67	803182802	ANELLO OR	6
35	080008282	CORPO POMPA	1
36-kit 123	803182802	ANELLO OR	6
37	852579002	TAPPO G3/8	1
37	852579532	TAPPO G3/8 OT (OPTIONAL)	1
38	824109002	GUARNIZIONE	1
39	812870002	CUSCINETTO	2
40	863510002	VITE	8
41-kit 270-271	802066302	PACCO GUARNIZIONE U 20-30	3
42-kit 270-271	802301202	ANELLO PULITORE	3
44-kit 67	070040282	TAPPO VALVOLA M27x1,5	6
45	862415602	VITE	3
48	843620052	ROSETTA IN RAME	3
50	060123612	LAMIERINO BLOCCAGGIO SPIE	1
51	089829973	KIT PIEDINI (OPTIONAL)	1
55	863212002	VITE (OPTIONAL)	4
56	080053612	PIEDINO (OPTIONAL)	2
57	806534002	LINGUETTA	1
58-kit 147	803262002	ANELLO OR (DA 06/2020)	1
58	803265002	ANELLO OR (FINO A 06/2020)	1
REPAIR KIT	ITEM NO,s INCLUDED	PCS.	
kit 67	049839973	KIT RICAMBI	12
kit 123	069867973	KIT RICAMBI	12
kit 146	089816973	KIT RICAMBI	3
kit 147	089817973	KIT RICAMBI	11
kit 270	089854973	KIT RICAMBI	25
kit 271	089855973	KIT RICAMBI	19