

RX 1950 - 2350 - 3050 - 3250

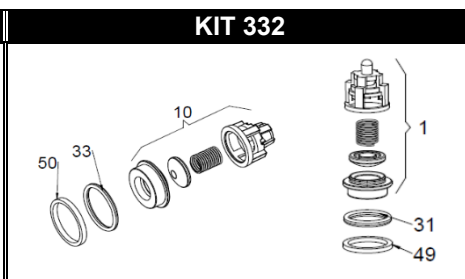
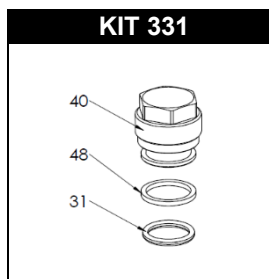
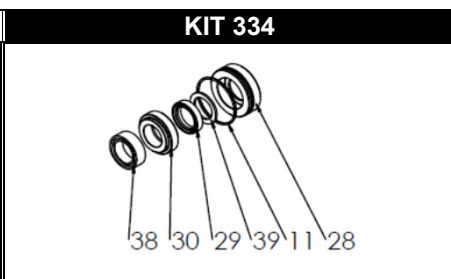
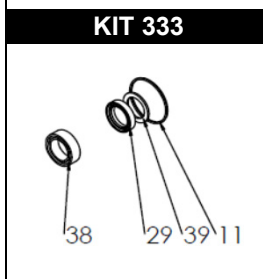
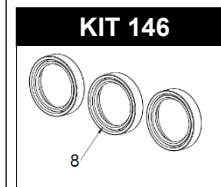
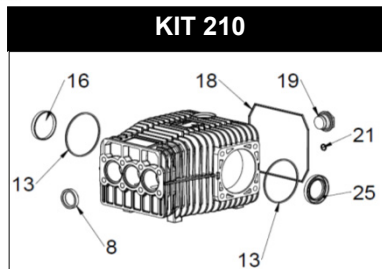
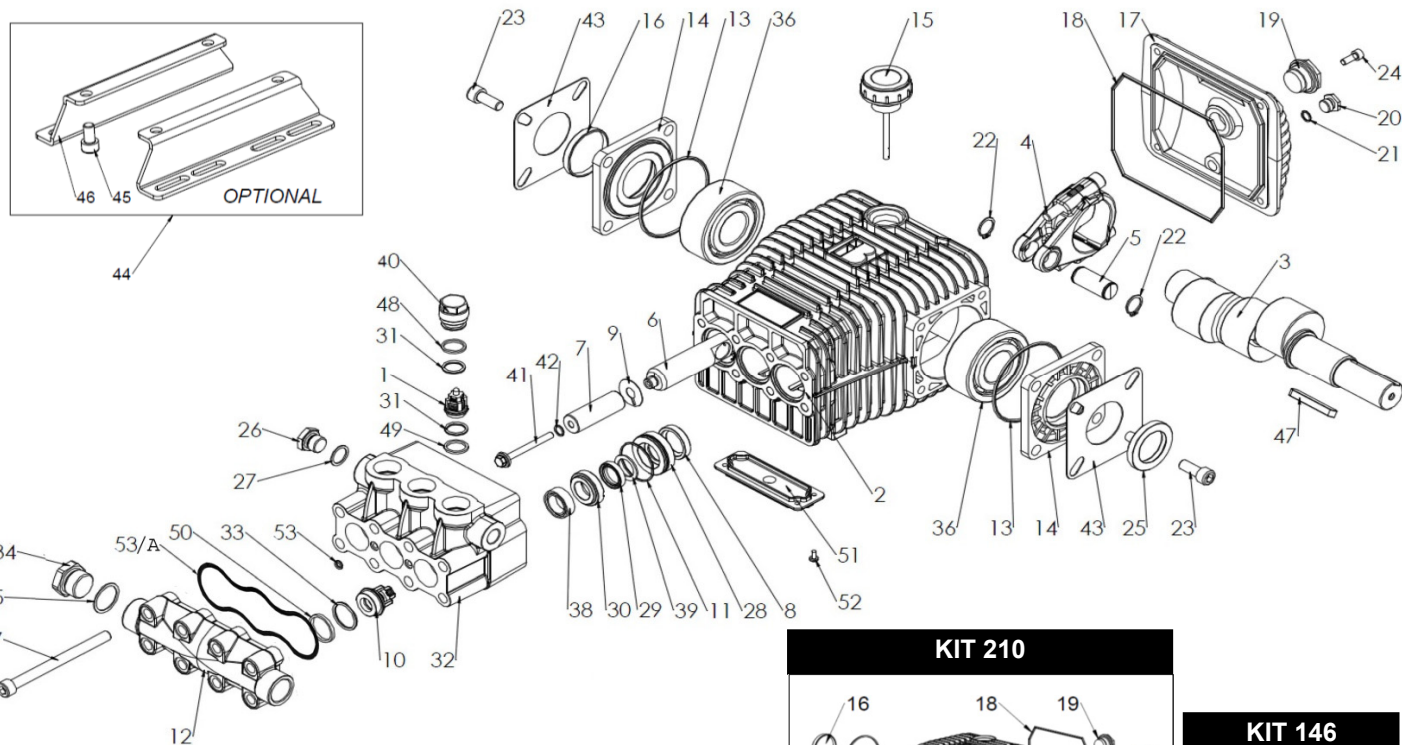

POS.	CODICE PART NO. RÉF.	DENOMINAZIONE - DESCRIPTION - DESCRIPTION	Q.TY
1-kit 332	08983797A	PRESSURE VALVES ASSEMBLY	3
2	180001092	PUMP CRANKCASE	1
3	180026262	CRANKSHAFT (RX 1960)	1
3	180024262	CRANKSHAFT (RX 2350)	1
3	180029262	CRANKSHAFT (RX 3050)	1
3	180023262	CRANKSHAFT (RX 3250)	1
4	080289112	CONNECTING ROD	3
5	080243492	PISTON PIN	3
6	080270512	PLUNGER ROD	3
7	180006182	CERAMIC PISTON D.20	3
8-kit 146-210	802092002	OIL SEAL D25	3
9	843827002	WASHER	3
10-kit 332	189800973	SUCTION VALVES ASSEMBLY	3
11-kit 333-334	803080202	O-RING	3
12	180003282A	SUCTION MANIFOLD	1
13-kit 210	803210712	O-RING	2
14	080249092	BEARING COVER	2
15	060020322	OIL FILLER PLUG WITH DIP STICK	1
16-kit 210	802099602	CAP	1
17	080006092	CRANKCASE COVER	1
18-kit 210	803210882	O-RING	1
19-kit 210	853515502	OIL SIGHT GLASS + O-RING	1
20	852543502	PLUG G1/4X9	1
21-kit 210	803057002	O-RING	1
22	801140002	CIRCLIP	6
23	863265002	BOLT M10X25 UNI 5931	8
24	862108002	BOLT M6X16 UNI 5931	4
25-kit 210	802143002	OIL SEAL	1
26	852579532	PLUG G3/8"	1
27	824109002	GASKET	1
28-kit 334	180005532	BACK GLAND D20	3
29-kit 333-334	802301102	"U" PACKING 20X28	3

POS.	CODICE PART NO. RÉF.	DENOMINAZIONE - DESCRIPTION - DESCRIPTION	Q.TY
30-kit 334	180004532	FRONT GLAND D20	3
31-kit 332-331	803182802	O-RING	6
32	180002282A	PUMP HEAD	1
33-kit 332	803204002	O-RING	3
34	852693532	PLUG G3/4"	1
35	824180002	GASKET	1
36	812871002	BEARING	2
37	863642002	BOLT M10X150 12.9 DACROMET	8
38-kit 333-334	802066602	GASKET RA 500 bar	3
39-kit 333-334	802301202	SCRAPER RING	3
40-kit 331	180011532	VALVE CAP	3
41	180015432	SPECIAL BOLT M6 A4 700 N/mm²	3
42	803008002	O-RING	3
43	060123612	SHEET	2
44	089829973	MOUNTING RAILS KIT (OPTIONAL)	1
45	863212002	BOLT M10X20 UNI 5931	4
46	080053612	MOUNTING RAIL (OPTIONAL)	2
47	806542202	TAB 8X7X56	1
48-kit 331	080250542	ANTIEXTRUSION RING 22,4X18,4	3
49-kit 332	080251542	ANTIEXTRUSION RING 22X17,5	3
50-kit 332	740109542	ANTIEXTR. RING D.25,7X30X3	3
51	180022322	COVER	1
52	864513002	BOLT M4X8 ISO 7045	4
53	803050002	O-RING (BEFORE 10/2020)	2
53/A	803210672	O-RING (FROM 11/2020)	1
REPAIR KIT	ITEM NO,s INCLUDED	PCS.	
kit 331	189807973	SPARE PARTS KIT	9
kit 146	089816973	SPARE PARTS KIT	3
kit 210	089839973	SPARE PARTS KIT	10
kit 333	189809973	SPARE PARTS KIT	12
kit 334	189810973	SPARE PARTS KIT	18
kit 332	189808973	SPARE PARTS KIT	18