

WMG 1" 4031-4037-4043

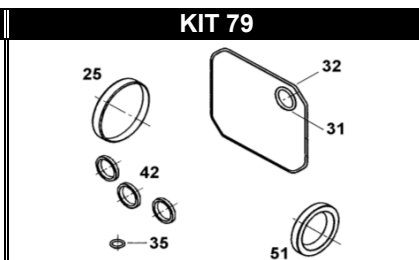
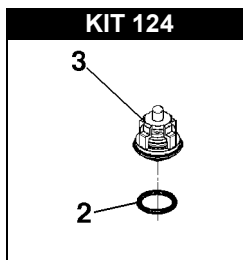
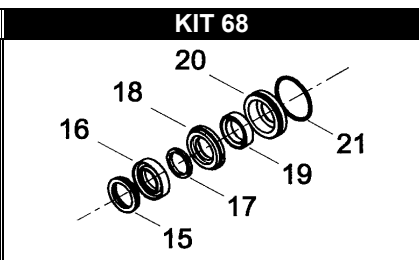
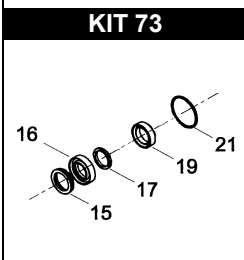
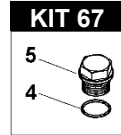
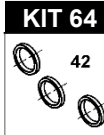
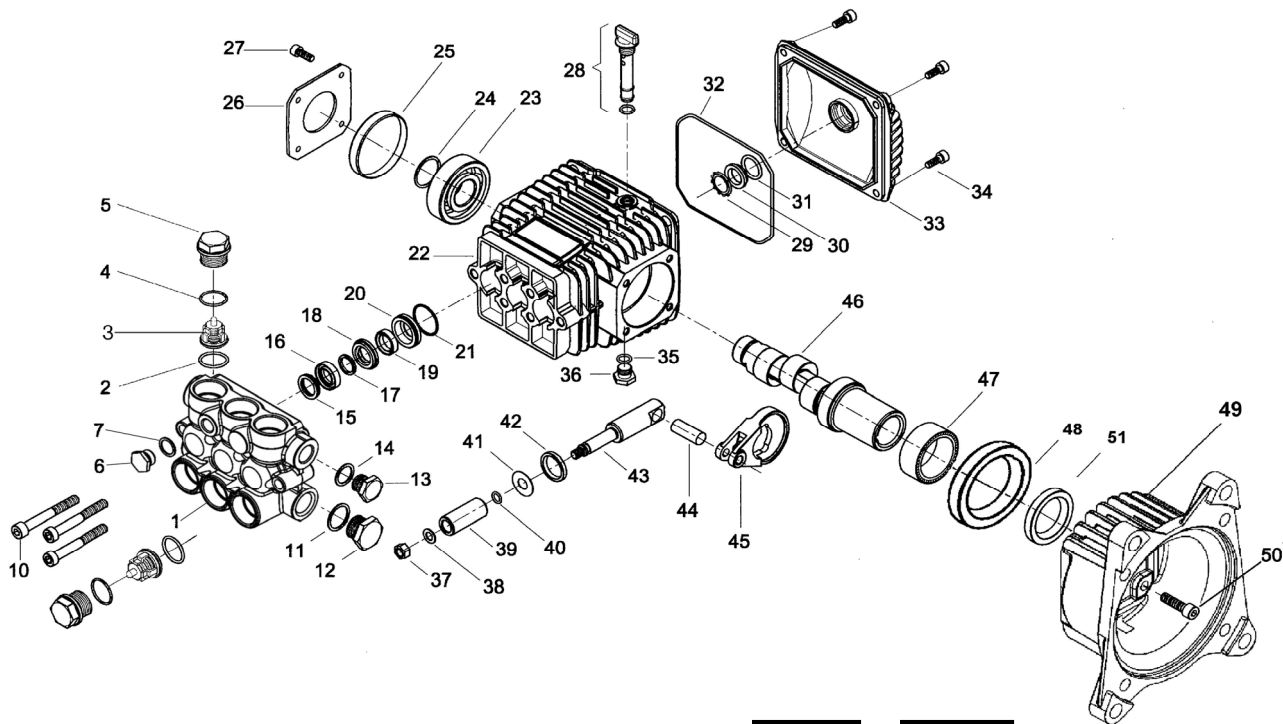

POS.	CODICE PART NO. RÉF.	DENOMINAZIONE - DESCRIPTION - DESCRIPTION	Q.TY	POS.	CODICE PART NO. RÉF.	DENOMINAZIONE - DESCRIPTION - DESCRIPTION	Q.TY
1	040473282	PUMP HEAD D.15 MM (FROM 18/04/2011)	1	30	040120322	OIL SIGHT GLASS	1
1	040119282	PUMP HEAD D.15 MM (BEFORE 18/04/2011)	1	31-kit 79	803189002	O-RING DIA.2,62X18,72	1
2-KIT 124	803182002	O-RING	6	32-kit 79	803210682	O-RING D.2,62X120,32	1
3-kit 124	049887973	CHECK VALVES	6	33	040117092	REAR COVER	1
4-kit 67	803182002	O-RING	6	34	862168002	GALVANISED BOLT M6X22 UNI 5931	4
5-kit 67	070040282	EX. DEEP SEALING VALVE CAP M27x1,5	6	35-kit 79	803057002	O-RING 2037 - 39.34 X 2.62	1
6	852543502	CAP G. 1/4" (FROM 18/04/2011)	1	36	852543502	CAP G. 1/4 X9	1
7	824079002	COPPER WASHER (FROM 18/04/2011)	1	37	814561002	NUT	3
10	862892002	BOLT M8X50 UNI 5931 (FROM 18/04/2011)	6	38	843642902	WASHER DIA.8,1X14X1	3
10	862945002	BOLT M8X60 UNI 5931 (BEFORE 18/04/2011)	6	39	040010182	CERAMIC PISTON DIA.15 MM.	3
11	824140002	GASKET	1	40	803049002	O-RING DIA.1,78X5,28	3
12	852629002	PLUG G 1/2	1	41	843726002	WASHER DIA.9,1X24X1	3
12	852629532	PLUG G 1/2 BRASS (OPTIONAL)	1	42-kit 64-79	802035002	OIL SEAL DIA.15X24X5	3
13	852579002	PLUG G 3/8	1	43	040107512	PLUNGER ROD	3
13	852579532	PLUG G 3/8 BRASS (OPTIONAL)	1	44	852003002	PISTON PIN DIA.8X25	3
14	824109002	GASKET DIA.17X22X1	1	45	040116112	BRONZE CONROD	3
15-kit 68-73	040270322	THRUST RING	3	46/1	040324262	HOLLOW SHAFT WMG 4031	1
16-kit 68-73	802020002	"V" PACKING D.15	3	46/2	040325262	HOLLOW SHAFT WMG 4037	1
17-kit 68-73	040269322	ANTI-EXTRUSION RING	3	46/3	040327262	HOLLOW SHAFT WMG 4043	1
18-kit 73	040268532	FRONT GLAND	3	47	812878902	BUSHING	1
19-kit 68-73	802034002	U PRESSURE SEAL DIA.15X22X5,5	3	48	040328412	BUSHING	1
20-kit 68	040166532	BACK GLAND	3	49	070077092	GAS ENGINE FLANGE SAE 1"	1
21-kit 68-73	803073002	O-RING DIA.23,52X1,78	3	50	862216002	BOLT M6X25	4
22	040110092	CRANKCASE	1	51- kit 79	802188002	OIL SEAL	1
23	812725002	BALL BEARING	1				
24	801185002	SNAP RING	1				
25-kit 79	802101002	CAP	1				
26	050045612	CRANKCASE COVER	1				
27	862108002	BOLT M6X16 UNI 5931	4				
28	049832973	OIL FILLER PLUG	1				
29	801184002	SNAP RING	1				
				REPAIR KIT		ITEM NO,s INCLUDED	PCS.
				kit 64	049836973	SPARE PARTS KIT	3
				kit 67	049839973	SPARE PARTS KIT	12
				kit 68	049840973	SPARE PARTS KIT	21
				kit 73	049843973	SPARE PARTS KIT	15
				kit 79	049842973	SPARE PARTS KIT	8
				kit 124	049890973	SPARE PARTS KIT	12