

WMC-F 1114-1120-1316-1320-1515-1520

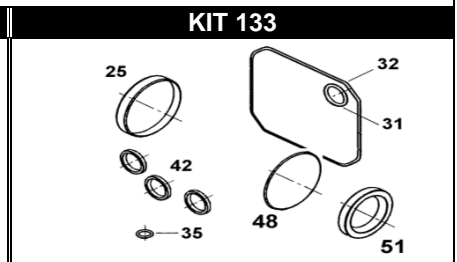
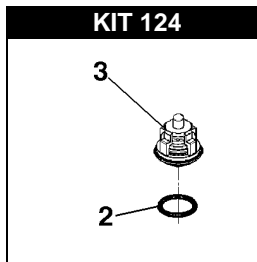
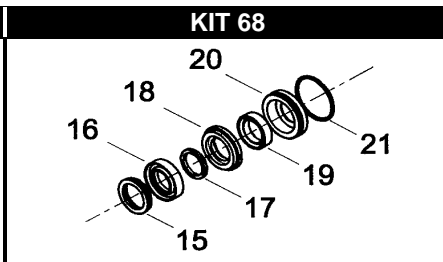
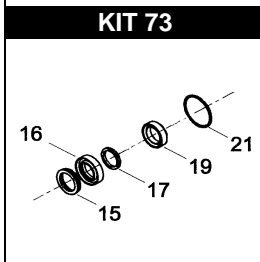
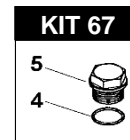
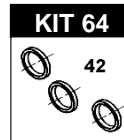
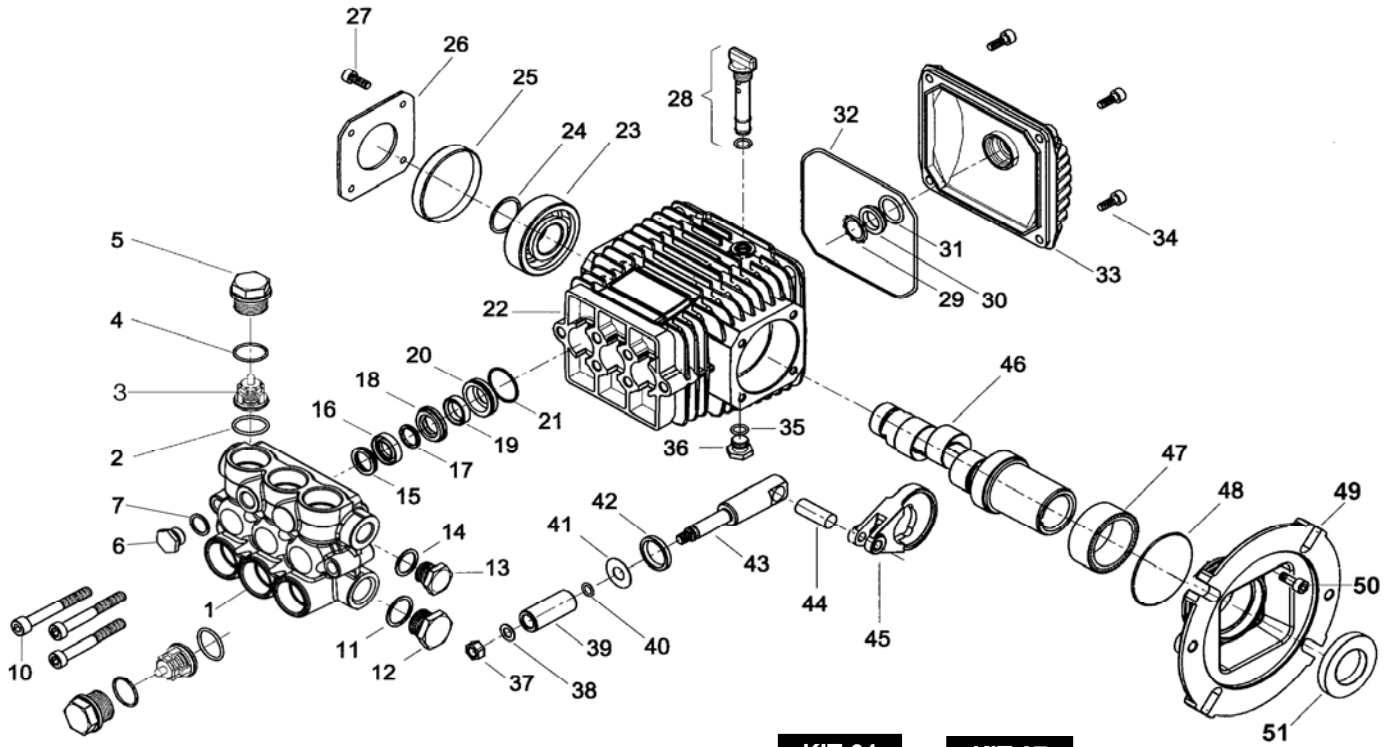

POS.	CODICE PART NO. RÉF.	DENOMINAZIONE - DESCRIPTION - DESCRIPTION	Q.TY
1	040473282	PUMP HEAD DIA.15 MM (FROM 18/04/2011)	1
1	040119282	PUMP HEAD DIA.15 MM (BEFORE 18/04/2011)	1
2-KIT 124	803182002	O-RING	6
3-kit 124	049887973	CHECK VALVES	6
4-kit 67	803182002	O-RING	6
5-kit 67	070040282	EX. DEEP SEALING VALVE CAP M27x1,5	6
6	852543502	CAP G.1/4" (FROM 18/04/2011)	1
7	824079002	COPPER WASHER (FROM 18/04/2011)	1
10	862892002	BOLT M8X50 UNI 5931 (FROM 18/04/2011)	6
10	862945002	BOLT M8X60 UNI 5931 (BEFORE 18/04/2011)	6
11	824140002	GASKET	1
12	852629002	PLUG G 1/2	1
12	852629532	PLUG G 1/2 BRASS (OPTIONAL)	1
13	852579002	PLUG G 3/8	1
13	852579532	PLUG G 3/8 BRASS (OPTIONAL)	1
14	824109002	GASKET DIA.17X22X1	1
15-kit 68-73	040270322	THRUST RING	3
16-kit 68-73	802020002	"V" PACKING D.15	3
17-kit 68-73	040269322	ANTI-EXTRUSION RING	3
18-kit 73	040268532	FRONT GLAND	3
19-kit 68-73	802034002	U PRESSURE SEAL DIA.15X22X5,5	3
20-kit 68	040166532	BACK GLAND	3
21-kit 68-73	803073002	O-RING DIA.23,52X1,78	3
22	040110092	CRANKCASE	1
23	812725002	BALL BEARING	1
24	801185002	SNAP RING	1
25-kit 133	802101002	CAP	1
26	050045612	CRANKCASE COVER	1
27	862108002	BOLT M6X16 UNI 5931	4
28	049832973	OIL FILLER PLUG	1
29	801184002	SNAP RING	1

POS.	CODICE PART NO. RÉF.	DENOMINAZIONE - DESCRIPTION - DESCRIPTION	Q.TY
30	040120322	OIL SIGHT GLASS	1
31-kit 133	803189002	O-RING DIA.2,62X18,72	1
32-kit 133	803210682	O-RING D.2,62X120,32	1
33	040117092	REAR COVER	1
34	862168002	BOLT M6X22 UNI 5931	4
35-kit 133	803057002	O-RING 2037 - 39,34 X 2,62	1
36	852543502	CAP G.1/4 X9	1
37	814561002	NUT	3
38	843642902	WASHER DIA.8,1X14X1	3
39	040010182	CERAMIC PISTON DIA.15 MM.	3
40	803049002	O-RING DIA.1,78X5,28	3
41	843726002	WASHER DIA.9,1X24X1	3
42-kit 64-133	802035002	OIL SEAL DIA.15X24X5	3
43	040107512	PLUNGER ROD	3
44	852003002	PISTON PIN DIA.8X25	3
45	040116112	BRONZE CONROD	3
46/1	040390262	HOLLOW SHAFT WMC 1114F-1120F	1
46/2	040391262	HOLLOW SHAFT WMC 1316F-1320F	1
46/3	040392262	HOLLOW SHAFT WMC 1515F-1520F	1
47	812878902	BUSHING	1
48-kit 133	803210002	O-RING DIA.2,62X56,82	1
49	050055092	ELECTRIC MOTOR FLANGE	1
50	862168002	BOLT M6X25	4
51-kit 133	802178002	OIL SEAL	1

REPAIR KIT	NO.s INCLUDED	PCS.	
kit 64	049836973	SPARE PARTS KIT	3
kit 67	049839973	SPARE PARTS KIT	12
kit 68	049840973	SPARE PARTS KIT	21
kit 73	049843973	SPARE PARTS KIT	15
kit 133	049920973	SPARE PARTS KIT	9
kit 124	049890973	SPARE PARTS KIT	12